

PANEL MOUNTING METHOD

Panel cut dimensions are as shown by the figure below.

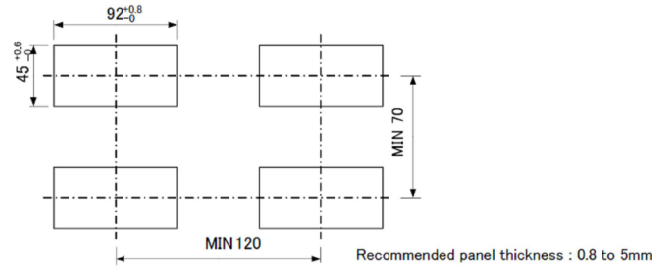

1) Removal of case fixing attachments

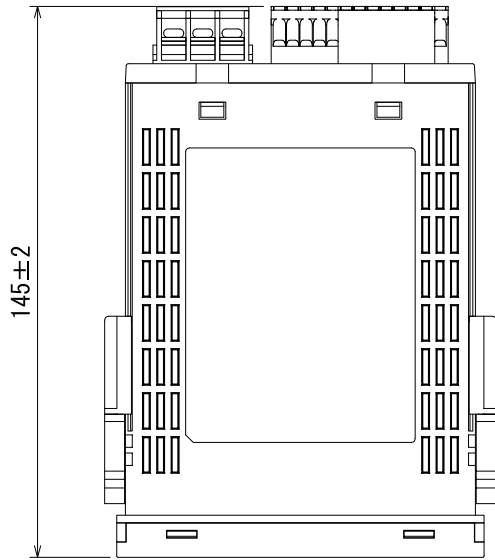
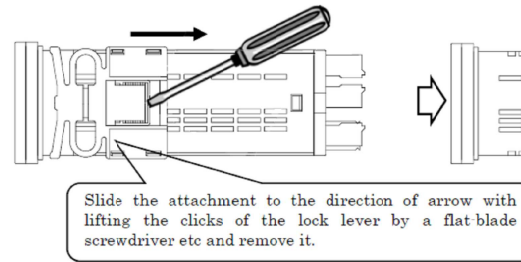

2) Installment of case fixing attachments

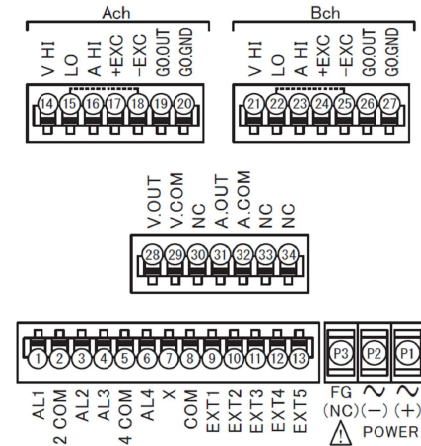
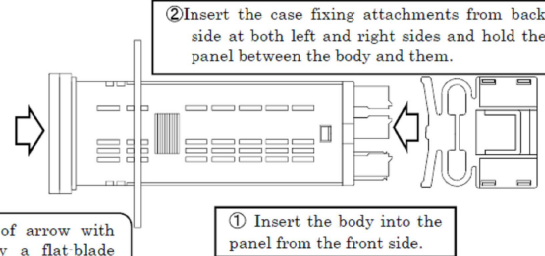

株式会社 Y.E.I.
大阪府吹田市江坂町 1-17-14 江坂吉川ビル 6F
TEL:06-6386-1081 (代) FAX:06-6384-7552

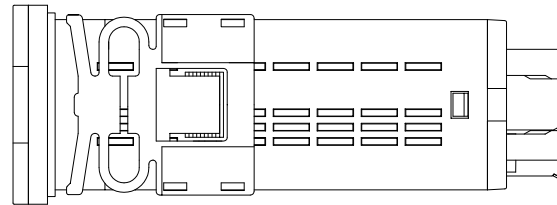
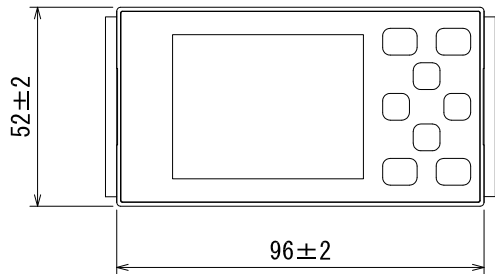

Input connector	No.	Name	Signal source	Send to
		⑮	Ach 「LO」	temperature converter⑥ (-) connector
	⑯	Ach 「A HI」	temperature converter⑤ (+) connector	
	⑳	Bch 「LO」	GM-115C Type capacitance converter 「C-OUT/OV (-) connector」	GM-115 GM-115
	㉑	Bch 「A HI」	GM-115C Type capacitance converter 「C-OUT/4~20mA (+) connector」	GM-115 GM-115
	㉒	POWER	Power supply AC100~240V±10% 50/60Hz	GM-115

Output connector	No.	Name	Sender	Send to	Note
		①	AL1	GM-115	Upper limit alarm output (NO)
	②	AL1-2 COM	GM-115	Upper limit alarm output (COM)	
	④	AL3	GM-115	Lower limit alarm output (NO)	a-contact output for Lower limit alarm
	⑤	AL3-4 COM	GM-115	Lower limit alarm output (COM)	
	③①	A. OUT	GM-115	DC4~20mA output (+) connector	DC4~20mA output
	③②	A. COM	GM-115	DC4~20mA output (-) connector	※ in the measuring range

			TITLE	EM-15 control unit				PROJECTION THIRD ANGLE	SCALE /	DWG No.	A 1 9 0 6 - 8 8 7 6 5/7
			REVISION	APPROVED	CHECKED	DRAWN	DATE				
M. K	DATE	REVISION									
							2019. 06. 25	Y. E. I. C O . , L T D .			